

Chevron, profile height 6, 12 & 13½ mm

C6 P1800 “Closed V”

Belt Width (A)	Cleat Width (B)	Cleat Pitch (C)	Plain Area (D)	Cleat Height (E)
600 mm ~ 1800 mm	600 mm ~ 1800 mm	75 mm		6 mm

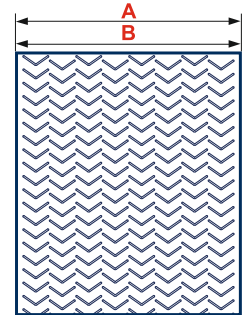
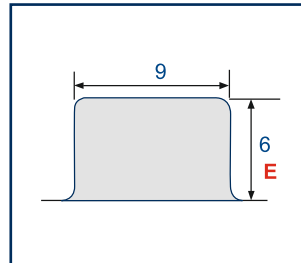

C12 V250 “Closed V”

Belt Width (A)	Cleat Width (B)	Cleat Pitch (C)	Plain Area (D)	Cleat Height (E)
300 mm	250 mm	152 mm	25 mm	12 mm
400 mm	250 mm	152 mm	75 mm	12 mm

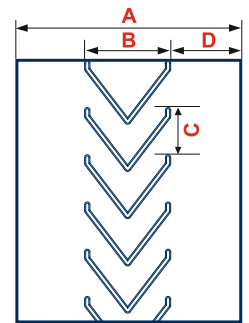
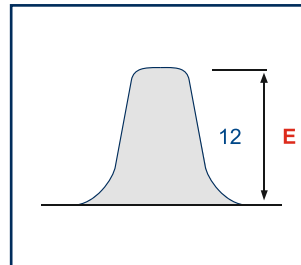

ES13½ “Closed V”

Belt Width (A)	Cleat Width (B)	Cleat Pitch (C)	Plain Area (D)	Cleat Height (E)
500 mm	500 mm	200 mm		13½ mm
650 mm	650 mm	200 mm		13½ mm
800 mm	800 mm	200 mm		13½ mm
1000 mm	1000 mm	200 mm		13½ mm

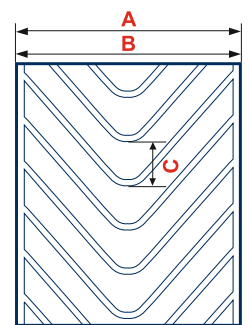
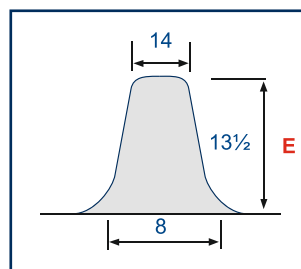

Chevron, profile height 15 mm

C15 V330 “Closed V”

Belt Width (A)	Cleat Width (B)	Cleat Pitch (C)	Plain Area (D)	Cleat Height (E)
400 mm	330 mm	250 mm	35 mm	15 mm
500 mm	330 mm	250 mm	85 mm	15 mm

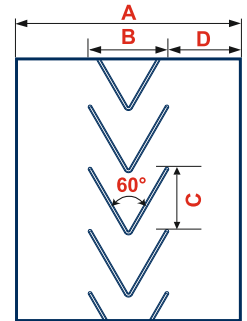
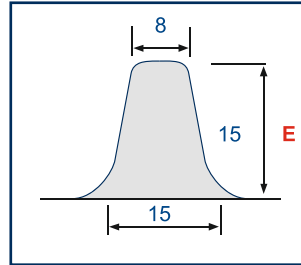

C15 V450 “Closed V”

Belt Width (A)	Cleat Width (B)	Cleat Pitch (C)	Plain Area (D)	Cleat Height (E)
600 mm	450 mm	300 mm	75 mm	15 mm
650 mm	450 mm	300 mm	100 mm	15 mm

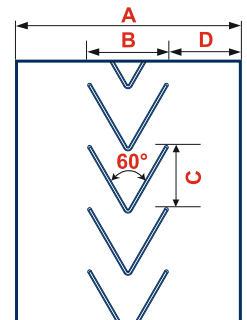
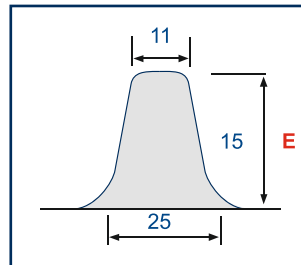

C15 P385 “Open V”

Belt Width (A)	Cleat Width (B)	Cleat Pitch (C)	Plain Area (D)	Cleat Height (E)
500 mm	385 mm	250 mm	58 mm	15 mm
600 mm	385 mm	250 mm	108 mm	15 mm
650 mm	385 mm	250 mm	133 mm	15 mm
800 mm	385 mm	250 mm	208 mm	15 mm

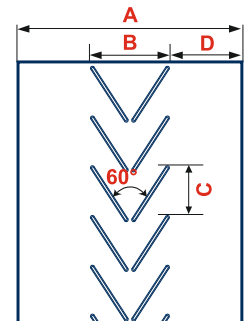
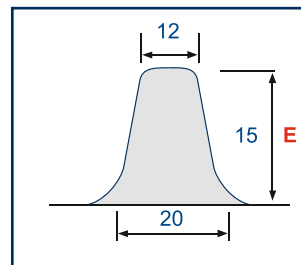

C15 P600 “Open V”

Belt Width (A)	Cleat Width (B)	Cleat Pitch (C)	Plain Area (D)	Cleat Height (E)
800 mm	600 mm	250 mm	100 mm	15 mm
1000 mm	600 mm	250 mm	200 mm	15 mm

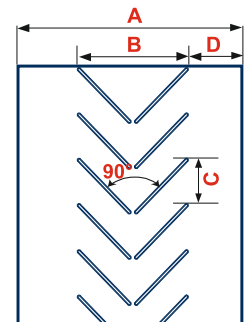
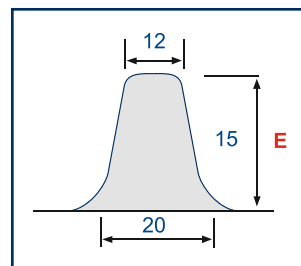

C15 P750 “Open V”

Belt Width (A)	Cleat Width (B)	Cleat Pitch (C)	Plain Area (D)	Cleat Height (E)
1000 mm	750 mm	250 mm	125 mm	15 mm
1200 mm	750 mm	250 mm	225 mm	15 mm

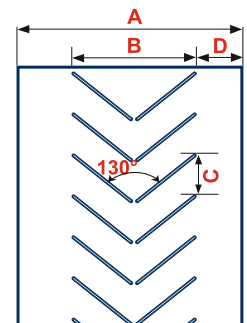
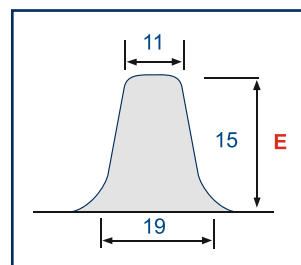

Chevron, profile height 17 mm

L30 "Open Y"

Belt Width (A)	Cleat Width (B)	Cleat Pitch (C)	Plain Area (D)	Cleat Height (E)
400 mm	300 mm	330 mm	50 mm	17 mm
500 mm	300 mm	330 mm	75 mm	17 mm

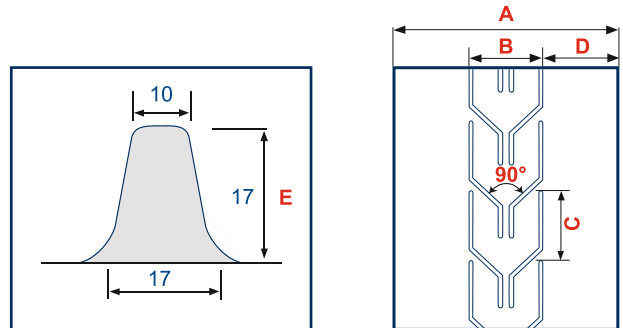

L44 "Open Y"

Belt Width (A)	Cleat Width (B)	Cleat Pitch (C)	Plain Area (D)	Cleat Height (E)
500 mm	440 mm	330 mm	28 mm	17 mm
600 mm	440 mm	330 mm	78 mm	17 mm
650 mm	440 mm	330 mm	103 mm	17 mm
800 mm	440 mm	330 mm	178 mm	17 mm

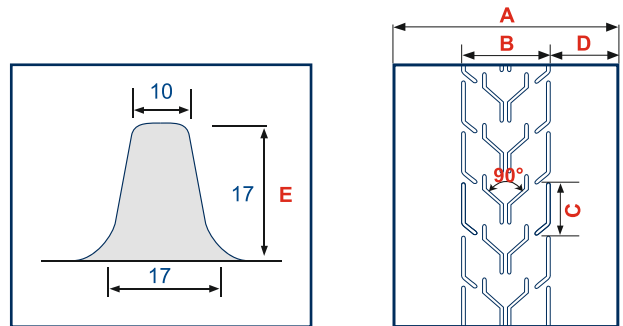

L55 "Open Y"

Belt Width (A)	Cleat Width (B)	Cleat Pitch (C)	Plain Area (D)	Cleat Height (E)
650 mm	550 mm	330 mm	50 mm	17 mm
800 mm	550 mm	330 mm	125 mm	17 mm

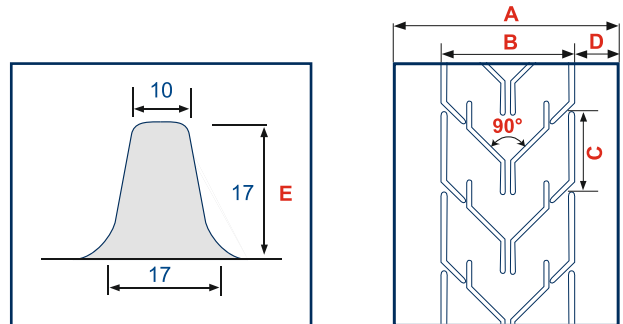

L63 "Open Y"

Belt Width (A)	Cleat Width (B)	Cleat Pitch (C)	Plain Area (D)	Cleat Height (E)
650 mm	630 mm	330 mm	10 mm	17 mm
800 mm	630 mm	330 mm	85 mm	17 mm
1000 mm	630 mm	330 mm	185 mm	17 mm

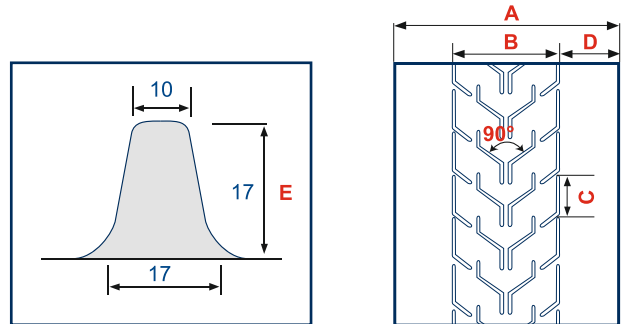

Chevron, profile height 17 mm

L75 "Open Y"

Belt Width (A)	Cleat Width (B)	Cleat Pitch (C)	Plain Area (D)	Cleat Height (E)
800 mm	750 mm	330 mm	25 mm	17 mm
1000 mm	750 mm	330 mm	125 mm	17 mm

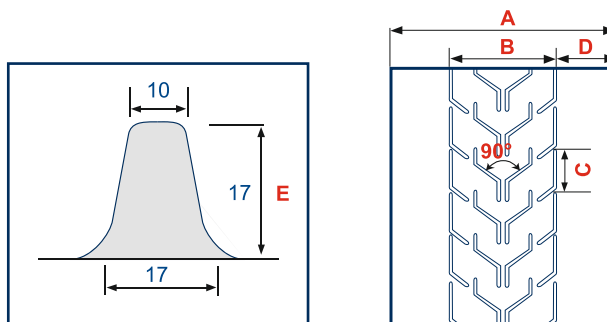

L95 "Open Y"

Belt Width (A)	Cleat Width (B)	Cleat Pitch (C)	Plain Area (D)	Cleat Height (E)
1000 mm	950 mm	330 mm	25 mm	17 mm
1200 mm	950 mm	330 mm	125 mm	17 mm

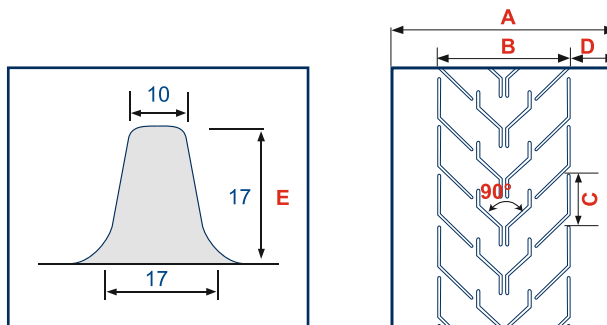

L129 "Double Y"

Belt Width (A)	Cleat Width (B)	Cleat Pitch (C)	Plain Area (D)	Cleat Height (E)
1400 mm	1290 mm	330 mm	55 mm	17 mm

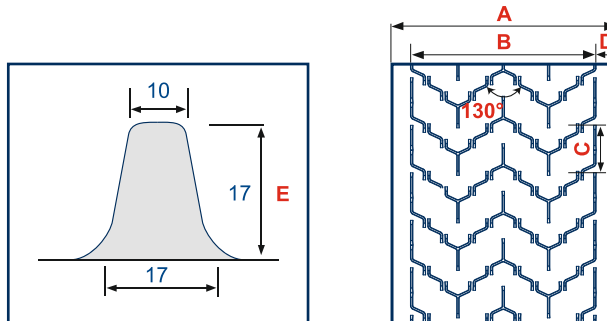

Chevron, profile height 25 mm

C25 P450 “Closed U”

Belt Width (A)	Cleat Width (B)	Cleat Pitch (C)	Plain Area (D)	Cleat Height (E)
600 mm	450 mm	330 mm	75 mm	25 mm
650 mm	450 mm	330 mm	100 mm	25 mm

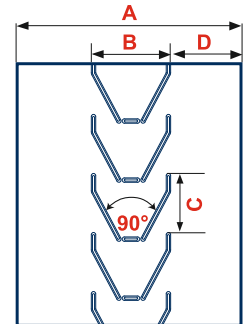
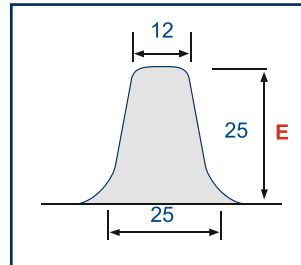

C25 P550 “Open U”

Belt Width (A)	Cleat Width (B)	Cleat Pitch (C)	Plain Area (D)	Cleat Height (E)
650 mm	550 mm	330 mm	50 mm	25 mm
800 mm	550 mm	330 mm	125 mm	25 mm

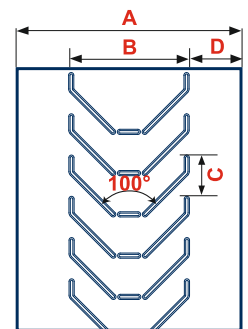
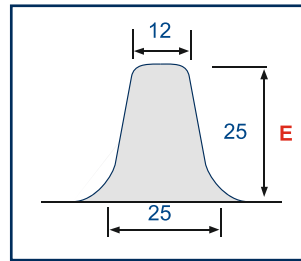

C25 P750 “Open U”

Belt Width (A)	Cleat Width (B)	Cleat Pitch (C)	Plain Area (D)	Cleat Height (E)
800 mm	750 mm	330 mm	25 mm	25 mm
1000 mm	750 mm	330 mm	125 mm	25 mm
1200 mm	750 mm	330 mm	225 mm	25 mm

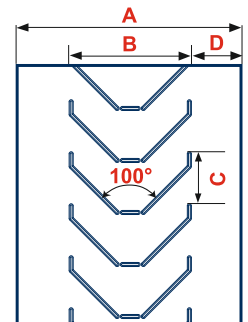
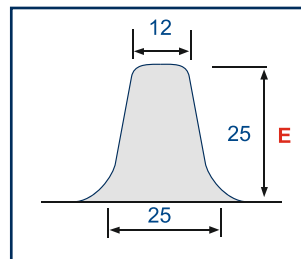

C25 P1000 “Open U”

Belt Width (A)	Cleat Width (B)	Cleat Pitch (C)	Plain Area (D)	Cleat Height (E)
1400 mm	1000 mm	400 mm	200 mm	25 mm
1600 mm	1000 mm	400 mm	300 mm	25 mm

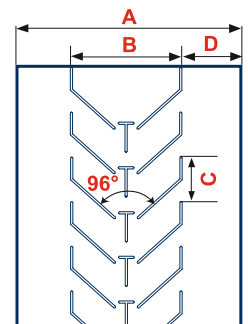
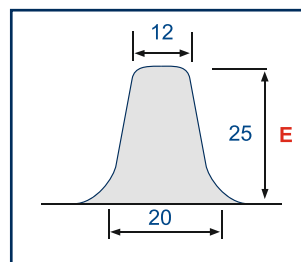

C25 P1335 “Open V”

Belt Width (A)	Cleat Width (B)	Cleat Pitch (C)	Plain Area (D)	Cleat Height (E)
1400 mm	1335 mm	500 mm	33 mm	25 mm
1600 mm	1335 mm	500 mm	133 mm	25 mm

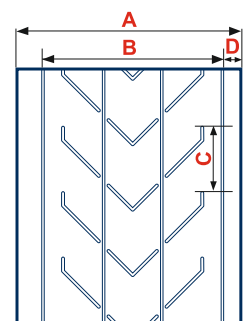
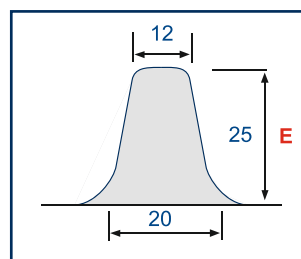

Chevron, profile height 32 mm

H 46

Belt Width (A)	Cleat Width (B)	Cleat Pitch (C)	Plain Area (D)	Cleat Height (E)
500 mm	460 mm	330 mm	20 mm	32 mm
600 mm	460 mm	330 mm	70 mm	32 mm
650 mm	460 mm	330 mm	95 mm	32 mm

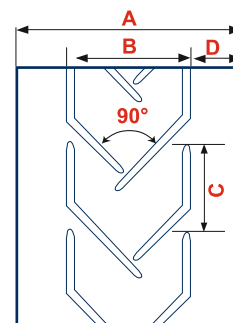
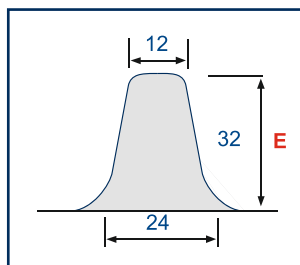

H 58

Belt Width (A)	Cleat Width (B)	Cleat Pitch (C)	Plain Area (D)	Cleat Height (E)
600 mm	580 mm	330 mm	10 mm	32 mm
650 mm	580 mm	330 mm	35 mm	32 mm
800 mm	580 mm	330 mm	110 mm	32 mm

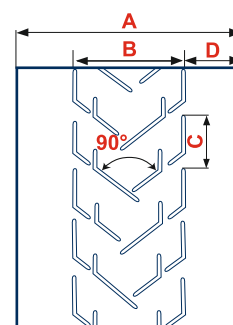
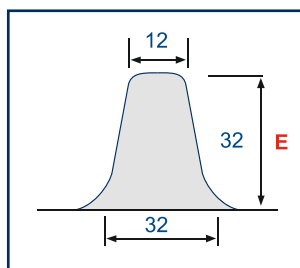

H 63

Belt Width (A)	Cleat Width (B)	Cleat Pitch (C)	Plain Area (D)	Cleat Height (E)
650 mm	630 mm	330 mm	10 mm	32 mm
800 mm	630 mm	330 mm	85 mm	32 mm
1000 mm	630 mm	330 mm	185 mm	32 mm

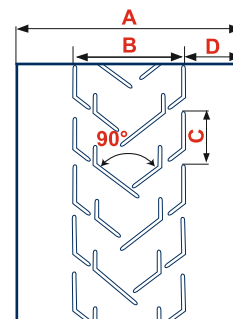
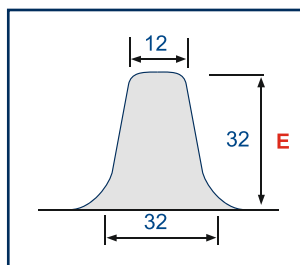

H 75

Belt Width (A)	Cleat Width (B)	Cleat Pitch (C)	Plain Area (D)	Cleat Height (E)
800 mm	750 mm	330 mm	25 mm	32 mm
1000 mm	750 mm	330 mm	125 mm	32 mm
1200 mm	750 mm	330 mm	225 mm	32 mm

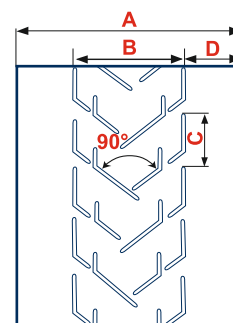
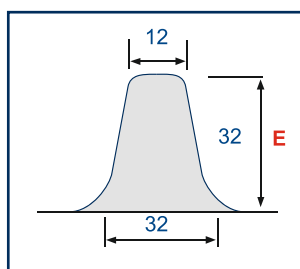

Chevron, profile height 30 & 32 mm

H 100

Belt Width (A)	Cleat Width (B)	Cleat Pitch (C)	Plain Area (D)	Cleat Height (E)
1200 mm	1000 mm	330 mm	100 mm	32 mm
1400 mm	1000 mm	330 mm	200 mm	32 mm

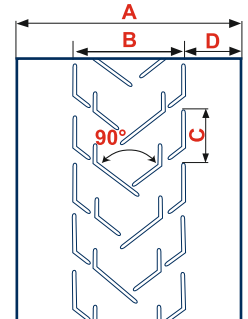
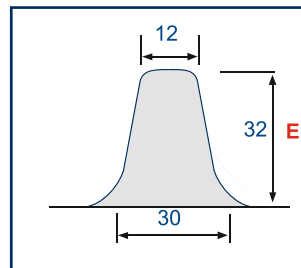

H 130

Belt Width (A)	Cleat Width (B)	Cleat Pitch (C)	Plain Area (D)	Cleat Height (E)
1600 mm	1325 mm	330 mm	138 mm	30 mm

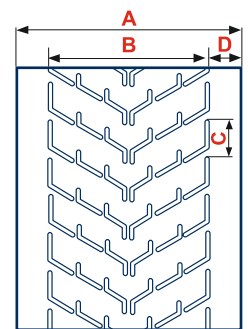
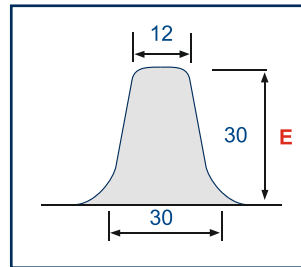

Chevron, profile height 32 mm

Y32 P450 “Open Y”

Belt Width (A)	Cleat Width (B)	Cleat Pitch (C)	Plain Area (D)	Cleat Height (E)
600 mm	450 mm	255 mm	75 mm	32 mm
650 mm	450 mm	255 mm	100 mm	32 mm

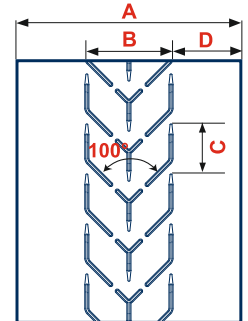
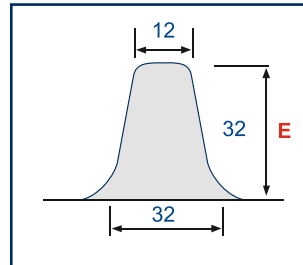

Y32 P600 “Closed Y”

Belt Width (A)	Cleat Width (B)	Cleat Pitch (C)	Plain Area (D)	Cleat Height (E)
800 mm	600 mm	300 mm	100 mm	32 mm
1000 mm	600 mm	300 mm	200 mm	32 mm

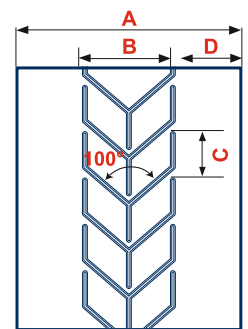
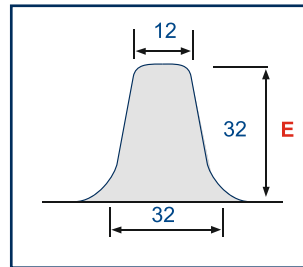

Y32 P800 “Open Y”

Belt Width (A)	Cleat Width (B)	Cleat Pitch (C)	Plain Area (D)	Cleat Height (E)
1000 mm	800 mm	345 mm	100 mm	32 mm
1200 mm	800 mm	345 mm	200 mm	32 mm

